

Sectional Garage Doors and Automatic Operators

NEW Range of sectional garage door colours







Introduction	4
Georgian and Linear designs	6
Choice of insulation options	8
Expert engineering and design	10
Your safety is our commitment	12
A harmonious overall appearance	14
Matching frame and door leaf	16
Excellent security and full drive-through width	17
Surface finishes	26
Colour options	27
Handle options	28
Window options	29
GaraMatic operators	30
GaraMatic operator features and models	32
BlueSecur app	38
GaraMatic operator accessories	39
User information, care and warranty	41
The Garador range	42

Since the company's policy is one of continuous improvement of its products, we reserve the right to make any alterations. Copyright. No part of this brochure may be copied or reproduced without our prior written permission.

Our doors are for residential purposes only and not for commercial use.





Introducing the Garador sectional garage door

Garador sectional garage doors are made up of separate sections that vertically lift and then run on tracks back into the garage. This allows for closer parking to the garage door as there is no "swing out". The door is available in a Premium 42 mm thick insulated version that's ideal for integral garages.

Four different door designs, six surface textures and a selection of RAL colours, mean there are an extensive range of door combinations, to suit homes with either modern or traditional architecture. Please see over leaf for further details.

Georgian and Linear designs

Choose from four different sectional garage door designs, each available in a variety of surface finishes and colours as detailed below.

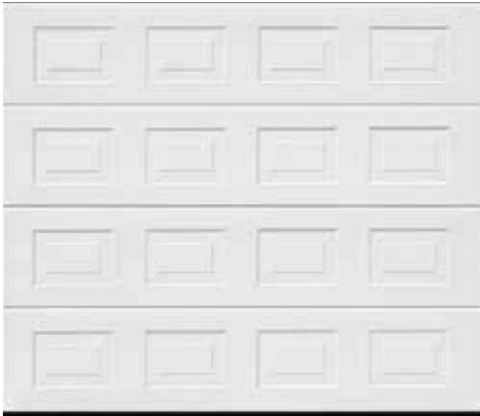

Georgian



Linear Small

SURFACE OPTIONS



Woodgrain

SURFACE OPTIONS



Woodgrain

INSULATION





Premium

INSULATION



Premium

 16 Standard Colours

 5 Timber Effect Finishes

 2 Standard Colours



Linear Medium



Linear Large

SURFACE OPTIONS



Woodgrain

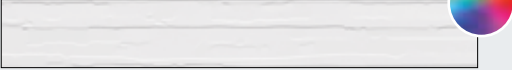

Slategrain

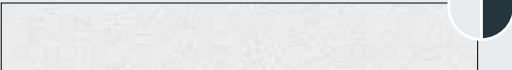

Sandgrain

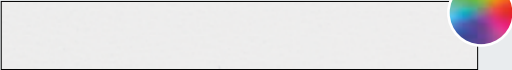

Silkgrain



Timber effect



Metallic finish

INSULATION



Premium

SURFACE OPTIONS



Slategrain



Sandgrain

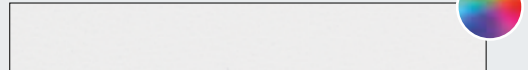

Silkgrain



Timber effect



Metallic finish

INSULATION

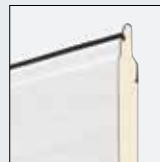

Premium



Excellent thermal performance

Our Premium sectional garage doors provide great thermal insulation, which is perfect for integral garages. Each door section is 42 mm thick and filled with CFC-free PU rigid foam. This is encased by a steel skin on both sides of the panel, for a strong and stable construction, and a seal between each section to prevent drafts.



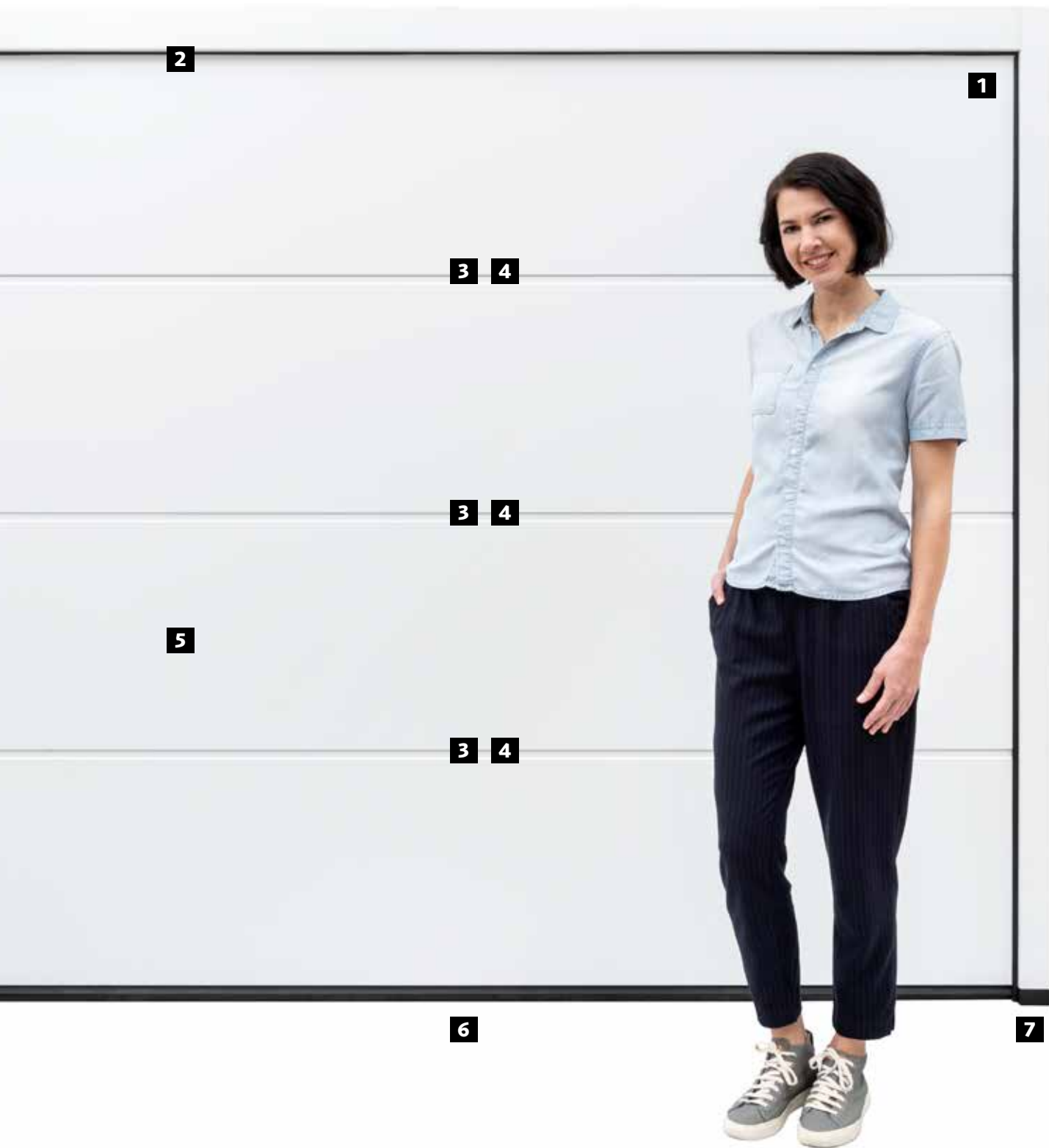

Expert engineering, designed for everyday use

Our sectional garage doors are expertly engineered for everyday use, with a range of features that ensure outstanding thermal performance, security and longevity.



Enhanced insulation with ThermoFrame
Garador's ThermoFrame provides up to 15% improved thermal insulation. The plastic profile, that's fitted to the door frame, creates a thermal break between the frame and brickwork. Extra rubber seals on both sides of the door and on the top door section, contribute to a better overall seal.



Durable paint finish
A durable powder-coat paint finish ensures the surface of your door is protected for the long-term. Choose from a selection of surface textures on page 22.

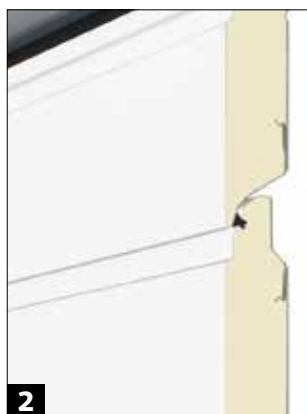

Flush fitting panels
For 42 mm premium sectional doors, a flush-fitting fascia panel is the most elegant solution for an invisible transition between the panel and door leaf. When the door is closed, the top door section is flush with the panel. Please note, intermediate seals only on 42 mm Premium insulated sectional doors.



Floor seal
A large bottom weather seal accommodates any slight inconsistencies in the surface of your floor, creating a tight seal and preventing drafts.

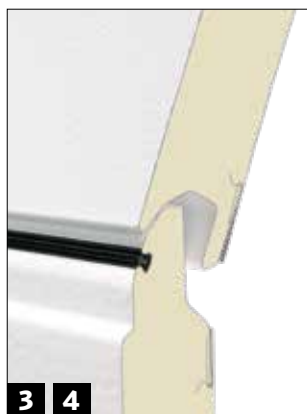

Outer edge and intermediate seals
Flexible and weather resistant seals on all four sides of the door help to keep the wind and rain outside. Intermediate seals between every section joint, further enhance the door's thermal insulation.



Plastic frame footer
A plastic protective cover is fitted to the base of both sectional door frame legs. This provides long-term protection against corrosion that might be caused by humid acids or salts, in a part of the door that is susceptible to rust.

Your safety is our commitment

Our sectional garage doors are engineered with safety as the first priority, which is why our designs incorporate a reliable anti-drop device, safety tracks to prevent the door de-railing, pinch protection and a side hand guard to eliminate the risk of finger trapping.



It's important to factor in how much headroom you have inside the garage, as this could affect the type of garage door you can fit. Our sectional garage doors with tension or torsion (low headroom) lifting gear, require just 100mm minimum headroom.



Side hand guard

The side tracks are completely enclosed, from top to bottom, so there are no gaps between the door leaf and the frame where fingers could get trapped.



Pinch protection

Each of the door sections have been designed specifically to prevent finger trapping. Each section rebate is optimally shaped as a finger protection profile that is effective both between the door section and on the hinges.



Anti-drop safety device

Garador sectional doors with either tension or torsion lifting gear, have an integrated anti-drop safety device. These systems prevent the door from crashing down in the event of a spring or cable failure.



Safe door travel

The combination of adjustable rollers, solid rollerbrackets and safety tracks, prevents the door sections from derailing.



BS EN 13241 Compliant
All Garador garage doors comply with the latest European safety standards.



CAFEDOR

A harmonious overall appearance and high quality production down to the last detail



A Our garage doors are distinguished by even, exact spacing of sections. The sections are shaped so that the transitions are practically invisible when the door is closed. See for yourself!

B Irregular spacing of sections due to different section heights coupled with visible section transitions on competitor doors. This gives the door an uneven look.



Matching appearance of frame and door leaf

It's the attention to detail that makes this Garador product superior. The colour and surface texture of Garador's sectional door frame and leaf are perfectly harmonised for a uniform appearance.

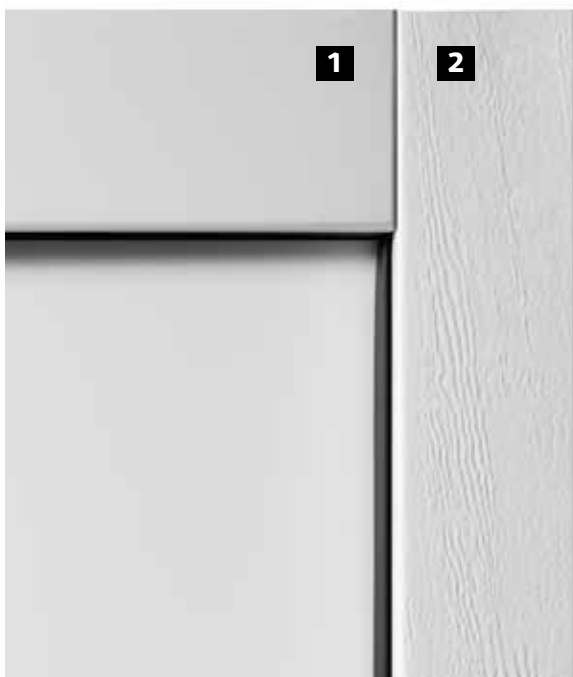

Matching White Frame and White Door

For sectional garage doors in Traffic White (RAL 9016), the top fascia panel **1** and frame cover profiles **2** are always provided to match the colour of the white sectional garage door. They are supplied in a white Woodgrain surface finish as standard.

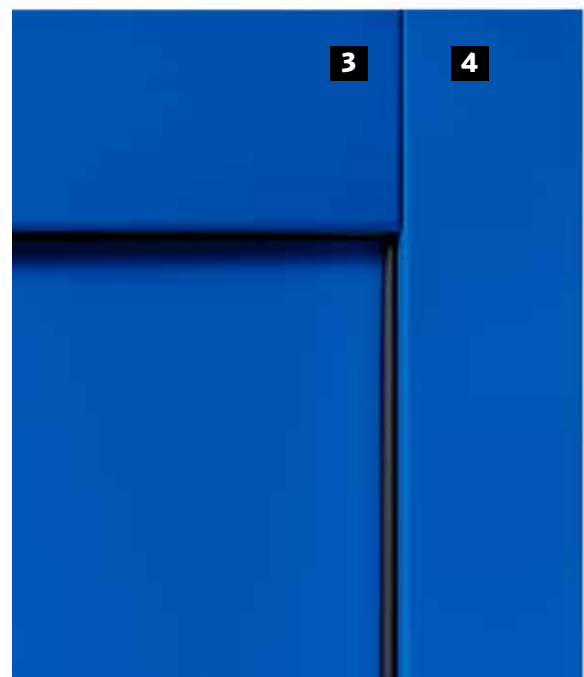

OPTION

Matching Coloured Frame and Coloured Door

The top fascia panel **3** always matches the surface finish and colour of the sectional garage door. Coloured sectional garage doors are optionally available with frame cover profiles **4** that match the surface finish and colour of the garage door sections.

Excellent security with anti-lift kit

For Garador automated sectional garage doors, the anti-lift kit in the operator's boom stop, prevents forced opening from unwanted intruders. GaraMatic operator is required.

Furthermore, any Garador Premium sectional garage door that is fitted behind the opening, automated with a GaraMatic operator and does not have any windows, is eligible for Secured by Design accreditation. Please note, the door must be unmodified and registered with Garador to qualify for Secured by Design accreditation.



Full drive-through width

The design of Garador's sectional garage door allows you to maximize drive-through width, as there are no lifting arms taking up precious space, as is the case with a traditional up & over garage door. This makes it much easier to park larger modern vehicles such as 4 x 4 s in your garage.

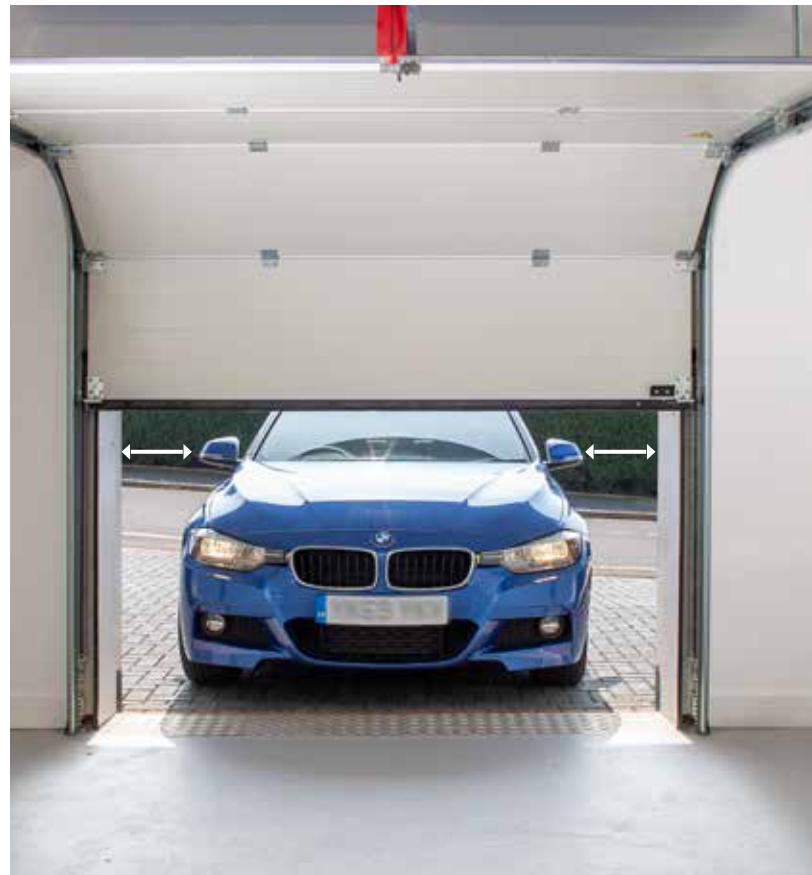

► Linear Medium garage door with Silkgrain surface finish in Slate Grey (RAL 7015).

▼ Linear Medium garage door with Silkgrain surface finish in Traffic White (RAL 9016).





◀ Linear Large garage door with Sandgrain surface finish in Anthracite Grey (RAL 7016).





◀ Linear Large garage door with Sandgrain surface finish in Anthracite Grey (RAL 7016).

▼ Linear Large garage door with Silkgrain surface finish in Basalt Grey (RAL 7012).





▲ Linear Large garage door with matching FrontGuard FGS 700 entrance door in Traffic White (RAL 9016).

▶ Linear Large garage door with Silkgrain surface finish in Light Grey (RAL 7035)





▲ Linear Medium garage door with Slategrain surface finish in Anthracite Grey (RAL 7016).

► Linear Large garage door with Silkgrain surface finish in Traffic White (RAL 9016).





Surface finishes



Woodgrain



Slategrain

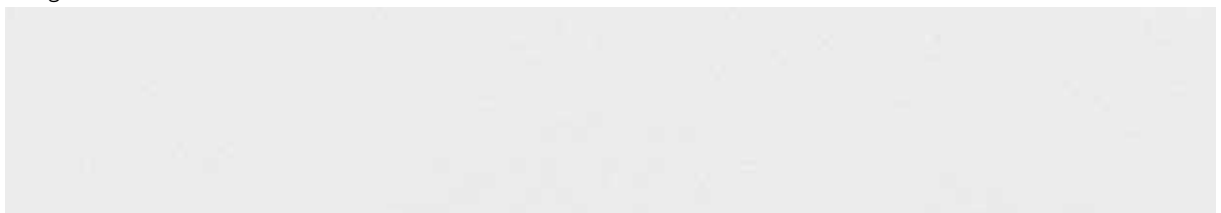

Sandgrain

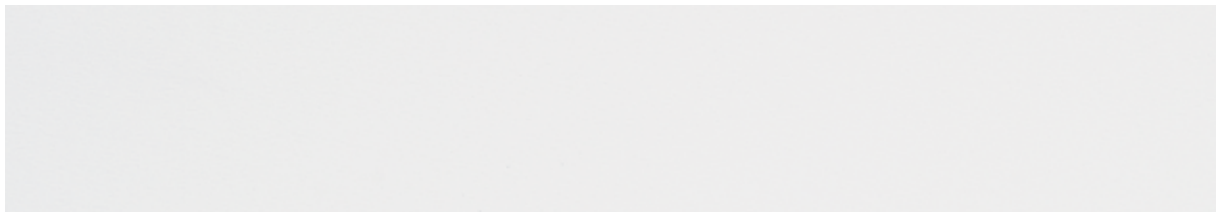

Silkgrain



Timber effect



Metallic finish

Standard colours and timber effect finishes



18 STANDARD COLOURS FOR WOODGRAIN, SLATEGRAIN AND SILKGRAIN SURFACE



Titan Metallic (CH 703)



Grey Aluminium (RAL 9007)



White Aluminium (RAL 9006)

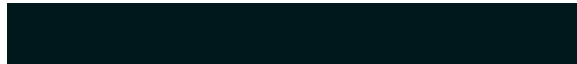

Jet Black (RAL 9005)



Terra Brown (RAL 8028)



Window Grey (RAL 7040)



Quartz Grey (RAL 7039)



Agate Grey (RAL 7038)



Light Grey (RAL 7035)



Stone Grey (RAL 7030)



Anthracite Grey (RAL 7016)



Slate Grey (RAL 7015)



Basalt Grey (RAL 7012)



Fir Green (RAL 6009)



Moss Green (RAL 6005)



Light Ivory (RAL 1015)



Traffic White (RAL 9016)



Chartwell Green (BS 14C35)



5 TIMBER EFFECT SURFACE FINISHES



Golden Oak



Rosewood



Dark Oak



Night Oak



Winchester Oak



2 STANDARD COLOURS FOR SANDGRAIN SURFACE

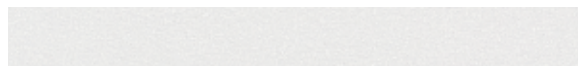

Traffic White (RAL 9016)



Anthracite Grey (RAL 7016)

In addition to the above standard colours we can also paint your door to any RAL colour to suit your individual requirements. RAL to Choose and Non-standard RAL colours are not available in all surface finishes. Please refer to Garador price list for details.

Printed colour samples are as accurate as printing techniques allow.

Design handles for manually operated sectional doors

All doors are supplied without a handle set and are therefore prepared for electric operation as standard. Please choose from the handle range shown for manual operation or your individual design requirements.

Design handles options



1



2



3



4

- 1 Black synthetic material
- 2 White
- 3 Brown finish
- 4 Brushed stainless steel



Choose from a range of window options

Choosing a window option gives style and character to your sectional garage door and has the benefit of allowing natural light into your garage. You can choose between clear and crystal panes in your windows on a sectional door.



1



2



3



4



5



6



7

Window options for Georgian designs, Linear Medium and Linear Large designs

- 1 Standard
- 2 Diamond
- 3 Cross
- 4 Sunrise*

*The Sunrise design varies depending on the number of windows (only available on Georgian doors).

Window option for all Linear designs

- 5 Linear 1

Window options for Medium and Large Linear designs

- 6 Linear 2
- 7 Linear 3

Window frames and rails made of synthetic material, white as standard, colour-match to the door is optional. Window frames for timber-effect doors are colour-matched as standard.





Open your garage door at the touch of a button

Our GaraMatic electric operators enable you to open and close your garage door at the touch of a button. Whether driving home in your car or standing outside your garage, you can simply press a button and the door will open.

GaraMatic operators and Garador garage doors are a tried and tested combination, perfectly matched and prepared for easy installation. Choose from three operator units: GaraMatic 9, GaraMatic 10 and GaraMatic 20.



All Garador operators come with a comprehensive 5 year warranty

GaraMatic operator features

Our range of GaraMatic operators have been designed to provide years of reliable service and the convenience of opening your garage door at the touch of a button. Energy efficient LED lighting, a power saving mode and smartphone connectivity are perfect for modern lifestyles.

	GaraMatic 9	GaraMatic 10	GaraMatic 20
Opening speed	20 cm/ second	25 cm/ second	25 cm/ second
Pull and Push Forces	600 N	650 N	750 N
Peak Force	750 N	800 N	1000 N
Maximum door width	5000 mm	5500 mm	5500 mm
Integral LED light	10 LED lights	20 LED lights	30 LED lights
Adjustable LED light for energy efficiency		•	•
Automatic safety reversal	•	•	•
Anti-lift kit	•	•	•
Remote status query	•	•	•
Bi-directional radio technology	•	•	•
868 MHz high-frequency signals	•	•	•
Soft start and soft stop	•	•	•
Low Power Consumption (< 1 watt)	•	•	•
Self-closing timer		•	•
Integral light strobes during operation		•	•
Half-open function for ventilation (only with climate sensor)		•	•
Third-open function for ventilation (only with climate sensor)		•	•
Integrated bluetooth receiver for controlling operator using Garador App		•	•
HCP interface to connect accessories or external SmartHome systems (i.e. Apple HomeKit)		•	•



GaraMatic 9
peak force 750 N
incl. two 4-button hand transmitters



GaraMatic 10
peak force 800 N
incl. two 4-button hand transmitters



Integrated bluetooth receiver as standard



GaraMatic 20
peak force 1000 N
incl. two 4-button hand transmitters



Integrated bluetooth receiver as standard



Engineered for security and convenience

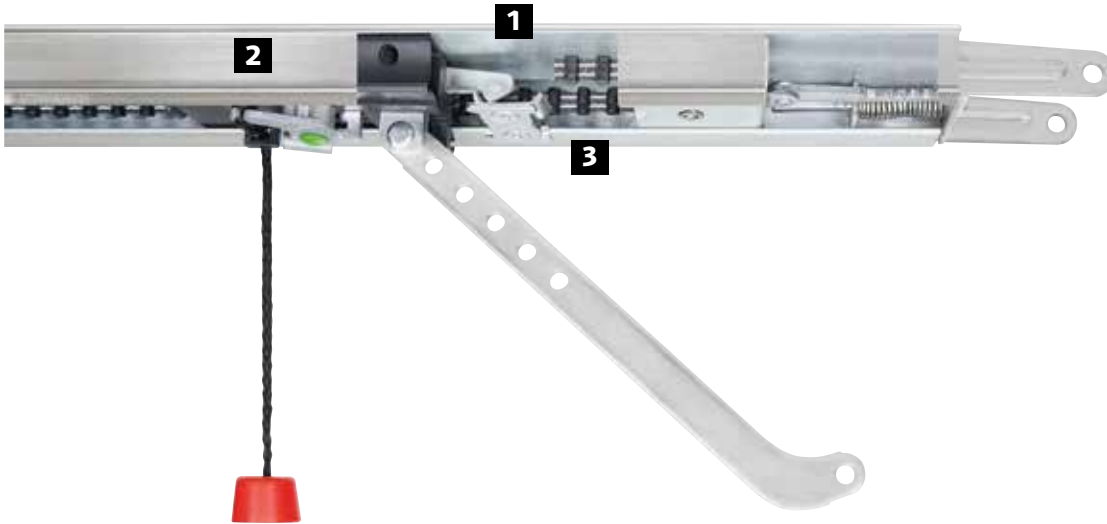

1 Mechanical lock inside boom for security. As soon as the garage door is closed, the anti-lift kit automatically engages in the operator's boom stop, preventing any forced entry. This is a mechanical process which functions without the need for a power supply.

2 Emergency release from inside. The pull handle provide an emergency release, so the door can be conveniently opened from the inside in the event of a power failure.

3 Maintenance-free tooth belt. Unlike operators with a chain or spindle design, Garador's kevlar toothed belt does not require grease or lubricants and is therefore maintenance free. The belt is reinforced with aramid fibres, so it is tear resistant and quiet.



LED Lighting for energy efficiency
GaraMatic operators feature an integral LED light for energy efficiency. Furthermore, each model has a low power consumption of less than 1 watt in stand-by mode.



Third ventilation opening position
In addition to the half-open ventilation position, our GaraMatic operators also have a one-third ventilation position. This feature is only activated with the use of the climate sensor.



Easy to connect
A larger and more accessible connection compartment on the back of the operator, makes the integrated circuit board easier to access when connecting accessories or smarhome systems.

Check the position of your garage door

All GaraMatic operators have a remote status query feature*, so you no longer have to go outdoors in all kinds of weather to check that your garage door is closed. Simply press the button on your hand transmitter and the colour LED will indicate the door position.

* 5-button bi-directional hand transmitter required



Display of 5-button
hand transmitter

- 1 Door is open
- 2 Door is closed



Automatic safety reversal

For your safety, all GaraMatic operators comply with the latest European safety standards (BS EN 13241). They have an automatic safety reversal feature, which uses force limitation, to recognise when there is an obstruction in the path of the door, at which point the door will stop and reverse allowing the obstruction to be removed.



Bi-directional radio technology

Our operators use bi-directional FM radio signals, that have the same 128-bit encryption used by banks for online security. This technology makes the electric operator even more secure and ensures a more reliable signal and extended range.



Control your garage door with your smartphone

We use our smartphones everyday to talk, type messages and browse the internet. With Garador's new BlueSecur app, you can quickly and conveniently operate your garage door using your smartphone too. An integrated bluetooth receiver provides a secure, reliable connection. The bluetooth receiver can be turned on or off.

Our range of genuine GaraMatic operator accessories, such as hand transmitters, code switches and wall consoles, are still available for a more traditional control device.

Garador BlueSecur App

- Control your GaraMatic operator (open/ close/ open partially/ light) from your smartohone.
- Quick and easy-to-use interface.
- Push notifications when receivers come into range.
- Free download from App store or Google Play.
- One free user key included. Others available via in-app purchase.

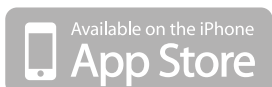

GaraMatic operator accessories



5 button Bi-directional hand transmitter

4 Control buttons, plus a status function. Available in matt black texture, high-gloss black or white.

The 5 button hand transmitter comes with a remote status query feature so you can check whether your garage door is closed at the press of a button.



2 button Bi-directional hand transmitter

Features 2 control buttons and an eyelet for a key ring. Available in high-gloss black or white, green and wood effect.



4 button Bi-directional hand transmitter

4 Control Buttons. Available in matt black texture with chrome or black end caps.

Features 4 control buttons and an eyelet for a key ring. The 4 button hand transmitter can be programmed to open up to four garage doors.



1 or 4 button Bi-directional hand transmitter

1 or 4 Control Buttons. Available in high-gloss black.

The 1 button hand transmitter combines convenience and style with the simplicity of a single button to operate your garage door.

The 4 button hand transmitter can be programmed to open up to four garage doors.



Hand transmitter station

Available in high-gloss black and white.

The hand transmitter station provides a handy and stable solution for storing your 5 button, 4 button or 1 button remote hand transmitter when it is not in use.

GaraRoll operator accessories



Transmitter for cigarette lighter
1-channel (fig. left)
2-channel (fig. right)

One or two key functions.
For insertion into Car cigarette lighter.
Battery operated.

In car transmitter plugs directly into your car cigarette lighter and can be programmed to open up to two garage doors.



Radio code switch FCT 3 BS

For 3 functions.
With illuminated buttons.

Surface mounted fitting possible, plastic housing in Light Grey (RAL 7040)



Radio code switch FCT 10 BS

For 10 functions
With illuminated buttons and hinged cover.

Surface mounted fitting possible, plastic housing in Light Grey (RAL 7040). Hinge cover painted in White Aluminium (RAL 9006).



Wired wall console IT3 B

3 functions
Supplied with 7 metre connecting lead (2 wires)

Button for opening and closing garage door. Plus additional buttons for light (on/ off) and operator (on/off). Painted in Pure White (RAL 9010).



Wireless wall console FIT 2 BS

3 button functions

Two push buttons for controlling up to 2 garage doors, via radio signal. One additional button for on/off function of connected external elements. Painted in Pure White (RAL 9010).



Internal push button IT 1b-1

Large, illuminated button for convenient opening of the door.

Plastic housing in Pure white RAL 9010

User information for the care of your garage door

A Garador garage door needs only a minimum level of preparation and maintenance to give years of trouble-free service. Below is a guide on how to get the best from your garage door.

Operation: Power-driven doors

- For opening and closing the door, when power-operated with an electric operator, press the button programmed to open the door on your hand transmitter. For those with a Series 4 GaraMatic 10 or GaraMatic 20 operator, you can also operate the garage door from the operator unit, by pressing the up arrow to open the door and the down arrow to close the door.
- During a power failure, you will have to open and close the door system by hand. For this, you have to disengage the operator. Please refer to your operator instructions for details.
- When the door is operated from either outside or inside, check the area through which the door will travel is clear from people and objects. Failure to do so may result in injury to persons or property.
- If the door is power-operated always try to ensure you match the door with a Garador electric operator to ensure full compliance with the Machinery Directive. If another make must be used always consider any compatibility/compliance issues

Operation: Manually operated doors

- For opening the door in manual operation use only the outside handle or inside handle.
- Only open and close the door using the supplied operating elements; these ensure a controlled, smooth action. Failure to comply with the above instructions may result in injury to persons or property.
- When closing the door, make sure that the latches engage fully and correctly.
- When the door is operated from either outside or inside, check the area through which the door will travel is clear from people and objects. Failure to do so may result in injury to persons or property.

Maintenance

- If in doubt about any of these maintenance procedures below always consult a Garador specialist. Garador Ltd. has a nationwide network of recommended installers who will be able to offer you a regular maintenance service on your garage door. Please call Garador or refer to the Garador website for further details of your nearest Installer.
- Immediately after the door is fitted and at least once a year, oil all pivot points, check screws and clamped connections for tightness, keep the running tracks clean (do not grease them), check parts and replace any worn components where necessary.

- Inspect all load-bearing components: Check the effectiveness of the detent pawl and the secure seat of the locking gear.
- Weight counterbalance: Check the counterbalance of the door leaf by manually opening the door halfway; the door should be able to hold this position. If the door moves substantially downwards, re-tension the torsion springs. The door should be able to balance in all positions.
- Fixing points: Check all the fixing points on the door and the building structure and make sure that all fastenings are securely seated and if necessary, retighten them.
- Rollers and tracks: When the door is closed, the rollers must be easy to turn. Adjust rollers if necessary (observe the operator fitting notes as they contain details on roller adjustment). Clean the tracks if necessary, but do not grease them.
- Hinges and roller holders: Make sure to oil the hinges and roller holders.
- Locking cylinders: Locking cylinders may not be cleaned with agents containing oil or be oiled. When cleaning the locking cylinders, only use specialised care products. Do not use oil or graphite.

Seals

- Check for damage, deformations and completeness of the rubber seals on door sections and around the door.

Cleaning

- The door and frame should be washed with a mild soap-based solution on a regular basis to prevent the build-up of dirt, salts and other corrosive substances and help maintain the aesthetic appearance of the product.
- If the door is installed in a seafront location, the door panel and frame should be cleaned in this way at least every two months.
- We also suggest that all other components be brushed down on a regular basis to prevent the build-up of dirt and dust etc.

Locking

- If the key is turned completely, the door is then locked or unlocked; when unlocked it is then possible to open and close the door by turning the handle.
- From the outside - To unlock: turn the key left 360°. To lock: turn the key right 360°.
- From the inside - To unlock: slide the locking lever on the lock upwards. To lock: slide the locking lever on the lock downwards.

Finish

The coating process applied to the door and chassis is environmentally friendly. Minor scratches or marks are not covered under the conditions of our warranty and should be repaired immediately to prevent corrosion and deterioration of the panel. Corrosive substances such as acids, alkalines, and salts, etc. should be cleaned from the door immediately; failure to do so will result in deterioration of the paint finish, which will not be covered under our warranty. Should deterioration of the finish start to occur you will need to repaint your door immediately. When repainting the door, prepare the surface lightly with wet and dry. Then treat with solvent based 2 pack epoxy wash primer and a normal commercial paint (cellulose paints must not be used). Dark colours should be avoided on Premium and Classic doors.

Warranty

In the unlikely event of a warranty claim becoming necessary, please contact the dealer or distributor who originally supplied your garage door. Your dealer should then supply details of the claim, together with a copy of the warranty card provided with the door and proof of purchase to the Warranty Department at Garador Ltd. To enable your claim under warranty to be processed as quickly as possible, you should provide the following details:

1. Your name, address and telephone number.
2. Original invoice with date of purchase.
3. Product description/door type and product number.
4. Description of defect.

An assessment of the claim will then be made. This may require Garador to inspect the product in-situ. In the event that there is no legitimate warranty claim under the terms specified herein, you may be liable for the costs of the inspection visit. We strongly recommend that you take note of the care and usage instructions displayed on the stickers on the back of your garage door, and on the page opposite, and that you follow these instructions throughout.

For further details please contact us on 01935 443 722, or through our website at www.garador.co.uk



View the full range of Garador garage doors

All Garador garage doors have been developed with reliability, safety and security in mind. We offer an extensive choice of up & over, side hinged, sectional and roller garage doors, each engineered with a different design so you are sure to find the right solution for your home. To find the right garage door for your home, please ask for the full Garador brochure range.

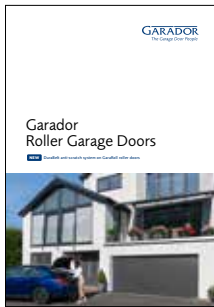
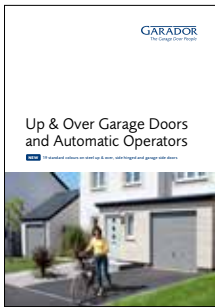

GARADOR

The Garage Door People

Bunford Lane, Yeovil, Somerset, BA20 2EJ
Tel: (01935) 443722 Fax: (01935) 443744

www.garador.co.uk



Garador is the UK's leading manufacturer of garage doors and operators, with an ultra-modern production facility located in Somerset. We use German engineering expertise to produce highly sophisticated doors and operators. By purchasing a Garador product you can be assured of the highest level of quality, safety and security. With a nationwide network of stockists, installers and service technicians we are an ideal partner for your project.